

## DAY FIFTEEN

# Adsorption and Catalysis

### Learning & Revision for the Day

- Concept of Adsorption
- Freundlich Adsorption Isotherm
- Langmuir Adsorption Isotherm
- Catalysis

The surface of a solid has the tendency to attract and retain the molecules of the phase with which it comes into contact. These molecules remain only at the surface and do not go deeper into the bulk. The accumulation of molecular species at the surface rather than in the bulk of a solid or liquid is called **adsorption**.

### Concept of Adsorption

- The solid substances on the surface of which adsorption occurs is called adsorbent. The molecular species that get adsorbed on the solid surface due to intermolecular attractions are called **adsorbate**.
- Rate of adsorption decreases with time whereas rate of absorption remains constant with time.
- If the concentration of an adsorbate at the surface of adsorbent is more than in the bulk of the adjoining phases, it is called **positive adsorption**.
- If concentration of an adsorbate at the surface of adsorbent is less than in the bulk of the adjoining phases, it is called **negative adsorption**.
- The removal of the adsorbed substance from a surface is called **desorption**.
- **Sorption** is a process in which adsorption and absorption take place simultaneously and it is difficult to determine the relative extent of adsorption and absorption, e.g. dyes get adsorbed as well as absorbed on the cotton fibres.

### Physisorption and Chemisorption

In **physisorption**, the particles of the adsorbate are held to the surface of the adsorbent by physical forces such as van der Waals' forces while in **chemisorption**, the molecules of the adsorbate are held to the surface of the adsorbate by chemical bonds.

### Comparison between Physisorption and Chemisorption

Physisorption	Chemisorption
Weak van der Waals' forces are present.	Strong chemical bonds are present.
It decreases with increase in temperature.	It first increases with increase in temperature and then decreases.
Heat of adsorption is low and it is in the range of 20-40 kJ/mol.	Heat of adsorption is high and it is in the range of 40-400 kJ/mol.
It is reversible process.	It is an irreversible process.
It is an instantaneous process.	It may be rapid or slow.
$\Delta S$ is always negative.	$\Delta S$ is positive for endothermic process.
In this, multilayer adsorption occurs and thus, adsorbed layer is several molecules thick.	In this, single layer adsorption occurs. Thus, adsorbed layer is only unimolecular in thickness.

**NOTE** As the particles of the adsorbate are held on surface,  $\Delta H$  and  $\Delta S$  both are negative and  $\Delta H > T\Delta S$ . This is true in beginning. As adsorption proceeds,  $\Delta H$  decreases and  $T\Delta S$  increases and ultimately,  $\Delta H = T\Delta S$  and  $\Delta G = 0$ . This state is called **adsorption equilibrium**.

## Factors Affecting Adsorption of Gases on Solids

Adsorption depends upon the following factors:

- Nature of Adsorbent** A gas is adsorbed in different amounts on different adsorbents. Hydrogen is strongly adsorbed on nickel surface while it is weakly adsorbed on alumina surface under identical conditions.
- Nature of Adsorbate** Generally, the more liquefiable a gas, the more readily will it be adsorbed. Easily liquefiable gases such as  $\text{NH}_3$ ,  $\text{HCl}$ ,  $\text{Cl}_2$ ,  $\text{SO}_2$ , etc., are readily adsorbed than permanent gases, such as  $\text{O}_2$ ,  $\text{H}_2$ ,  $\text{N}_2$  etc.
- Specific Area of Adsorbent** It is the surface area of adsorbent available for adsorption per gram of the adsorbate. Greater the surface area of the solid, larger would be its adsorbing capacity.
- Temperature** Low temperature value favours physical adsorption but at high temperature, it decreases. In chemisorption, extent of adsorption first increases and then decreases.
- Pressure of Gas** At a given temperature, the extent of adsorption will increase with the increase of pressure of the gas.

## Freundlich Adsorption Isotherm

- The variation in the amount of gas adsorbed by the adsorbent with pressure at constant temperature can be expressed by curve termed as adsorption isotherm.

- Freundlich gave an empirical relationship between the quantity of gas adsorbed by unit mass of solid adsorbent and pressure at a particular temperature.
- The extent of adsorption is measured as  $x/m$ , where  $m$  is the mass of adsorbent and  $x$  is the mass of adsorbate. At low pressure,  $x/m$  varies linearly with  $p$ .

$$\frac{x}{m} = kp^{1/n} \quad \text{or} \quad \log \frac{x}{m} = \log k + \frac{1}{n} \log p$$

At low pressure,  $\frac{x}{m} = kp$

At high pressure,  $\frac{x}{m} = kp^\circ$

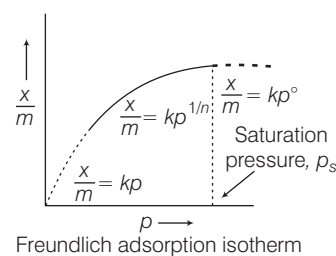

This is called **Freundlich adsorption isotherm** at constant temperature.

- Freundlich isotherm fails at high pressure and is only for physical adsorption.

## Langmuir Adsorption Isotherm

To overcome the limitation of Freundlich adsorption isotherm, Langmuir developed a new isotherm. It is represented as :

$$\frac{x}{m} = \frac{ap}{1 + bp} \quad (\text{a and b are constants})$$

- At very high pressure, ( $bp \gg 1$ )  $\frac{x}{m} = \frac{a}{b}$
- At very low pressure, ( $bp \ll 1$ )  $\frac{x}{m} = ap$

- In case of chemisorption,  $x/m$  initially increases with temperature and then decreases.
  - At low temperature,  $x/m$  is small. As temperature is increased, the molecules of the adsorbate gain energy and become equal to activation energy. Therefore, initially,  $x/m$  increases with rise in temperature.
- The graph between extent of adsorption ( $x/m$ ) and temperature  $T$  is called **adsorption isobar**.

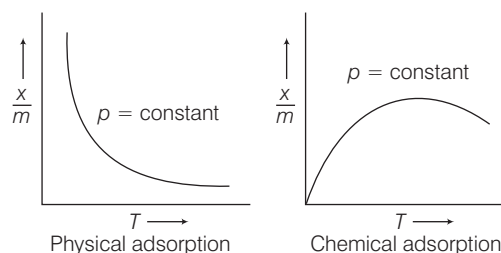

## Adsorption from Solutions

- Solids adsorb dissolved substances from solutions. For example, adsorption of colour impurities by activated carbon in decolourising of solutions.
- Freundlich adsorption isotherm and Langmuir adsorption isotherm are also applicable to adsorption from solutions.

Freundlich adsorption isotherm,  $\frac{x}{m} = kC^{1/n}$  ( $n > 1$ )

Langmuir adsorption isotherm,  $\frac{x}{m} = \frac{aC}{(1 + bC)}$

Langmuir adsorption isotherm is applicable only to chemisorption.

## Characteristics of Adsorption

- Adsorption is **specific and selective** phenomenon which strictly refers to the existence of a higher concentration of any particular component at the surface of a liquid or a solid phase.
- Adsorption is accompanied with decrease in free energy of the system. In adsorption, there is a decrease in entropy of the system.

As,  $\Delta G < 0$  and  $\Delta S < 0$ ,

Therefore,  $\Delta H < 0$  ( $\Delta H = \Delta G + T\Delta S$ )

Thus, adsorption is always an exothermic process.

- The atoms or molecules of a solid surface have unbalanced or **residual attractive forces on the surface**, which can hold adsorbate particles together. Thus, the adsorbed atoms or molecules can be held on the surface of a metal by physical van der Waals' forces or chemical forces due to residual valence bonds.
- Adsorption is not very pronounced unless an adsorbent possesses a large surface area for a given mass. Various types of charcoals, silica gels, metal, etc., are used as adsorbents. Appreciable adsorption also takes place on some smooth surfaces, such as those of platinum and glass.
- Charcoal and other solids increased power of adsorption on heating at low pressure with various gases or in air or vacuum at temperature varying from 350-1000°C. Such treated charcoal is called **activated charcoal** and the process is called **activation**.

## Catalysis

- The catalyst changes the rate of reaction by providing an alternate path of different activation energy. They themselves remain chemically and quantitatively unchanged after the reaction. The phenomenon is known as catalysis.
- **Promoters** are the substances which can increase the efficiency of a catalyst. These are also known as co-enzymes or activators.

- **Inhibitors** are the substances which can make the catalyst inactive, e.g.  $Mg^{2+}$  acts as an activator for many enzymes while  $C_2O_4^{2-}$  and  $F^-$  act as inhibitors as they form complex with  $Mg^{2+}$ .

**NOTE**

- The catalytic poisoning is specific in nature.
- In former case, catalyst surface is regenerated by scratching the surface while in later, catalyst surface is regenerated by chemical treatment.

## Homogeneous and Heterogeneous Catalysis

- (i) In **homogeneous catalysis**, reactants and catalyst should be in same phase.

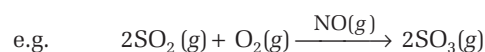

- (ii) In **heterogeneous catalysis**, reactants and catalyst are in different phase.

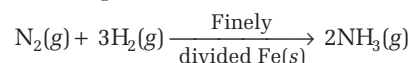

## Activity and Selectivity of Solid Catalysts

1. **Activity** of catalyst depends upon the strength of chemisorption to a large extent.
2. **Selectivity** of a catalyst is its ability to direct a reaction to yield a particular product. e.g.

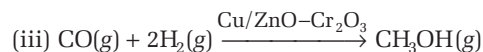
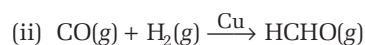
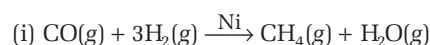

**NOTE** The catalytic reaction that depends upon the pore structure of the catalyst and the size of the reactant and product molecules is called **shape-selective catalysis**.

## Characteristics of Catalysts

- They become temporarily involved in a reaction providing an alternative reaction path of lower activation energy than that for the uncatalysed reaction.
- They catalyse both forward and backward reactions to the same extent and thus have no effect on the equilibrium constant.
- The catalyst remains unchanged in amount and chemical composition at the end of the reaction. It may undergo some physical change.
- In certain reactions, the rate of the reaction is dependent on the concentration of the catalyst, e.g. rate of inversion of cane sugar is dependent on the concentration of  $H^+$  used as catalyst.

- Rate of the reaction in certain heterogeneous reaction varies with surface area of the catalyst. Hence, finely divided metals are preferred in the form of catalyst.
- The catalyst does not initiate the reaction and are specific in their action, e.g. starting from  $H_2$  and  $CO$ , three different products are possible using different catalysts as

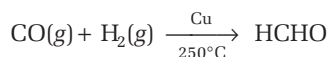
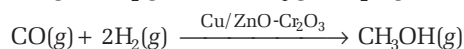
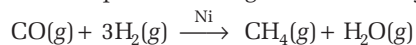

## Enzyme Catalysis and its Mechanism

Enzymes are biochemical catalysts. They are proteins and extremely specific in nature. For example,

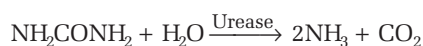

Mechanism for all enzyme catalysed reactions are

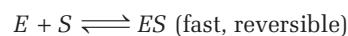

1. **Autocatalysis** is the phenomenon in which one of the products formed during the reaction acts as catalyst for the reaction. For example,

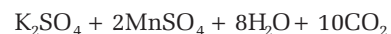

In this reaction,  $Mn^{2+}$  ions act as autocatalyst.

2. **Induced catalysis** is the type of catalysis, one reaction influences the rate of other reaction which does not occur under ordinary condition. For example, the reduction of  $HgCl_2$  by oxalic acid is slow but becomes faster if reduction is made in mixture of  $KMnO_4$  and  $HgCl_2$ , where both are reduced. Reduction of  $KMnO_4$  thus, induces the reduction of  $HgCl_2$ .

## DAY PRACTICE SESSION 1

# FOUNDATION QUESTIONS EXERCISE

- 1 Adsorption is a surface phenomenon because

- (a) adsorbent has large surface area
- (b) chemical compounds formed are not on the surface of adsorbent
- (c) only the surfaces of the adsorbent have unutilised valencies
- (d) None of the above

- 2 Which one of the following characteristics is not correct for physical adsorption?

- (a) Adsorption on solids is reversible
- (b) Adsorption increases with increase in temperature
- (c) Adsorption is spontaneous
- (d) Both enthalpy and entropy of adsorption are negative

- 3 Which of the following statements is incorrect regarding physisorption?

- (a) It occurs because of van der Waals' forces
- (b) More easily liquefiable gases are adsorbed readily
- (c) Under high pressure, it results into multimolecular layer on adsorbent surface
- (d) Enthalpy of adsorption ( $\Delta H_{\text{adsorption}}$ ) is slow and positive

- 4 Amount of gas adsorbed per gram of adsorbent increases with pressure, but after certain limit is reached, adsorption becomes constant. It is due to

- (a) multilayers are formed
- (b) desorption takes place
- (c) temperature is increased
- (d) absorption also starts

- 5 Which of the following is the variation of physical adsorption with temperature?

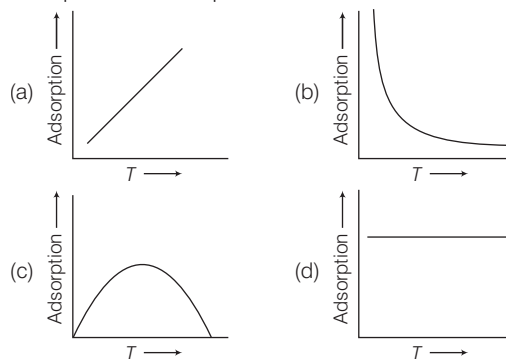

- 6 In the Freundlich adsorption equation  $x/m = kp^{1/n}$ , the value of  $n$  is

- (a) always greater than one
- (b) always smaller than one
- (c) always equal to one
- (d) greater than one at low temperature and smaller than one at high temperature

- 7 For a linear plot of  $\log(x/m)$  versus  $\log p$  in a Freundlich adsorption isotherm, which of the following statements is correct? ( $k$  and  $n$  are constants)

- (a)  $1/n$  appears as the intercept → JEE Main 2016
- (b) Only  $1/n$  appears as the slope
- (c)  $\log\left(\frac{1}{n}\right)$  appears as the intercept
- (d) Both  $k$  and  $1/n$  appear in the slope term

8 Which of the following is an adsorption isotherm?

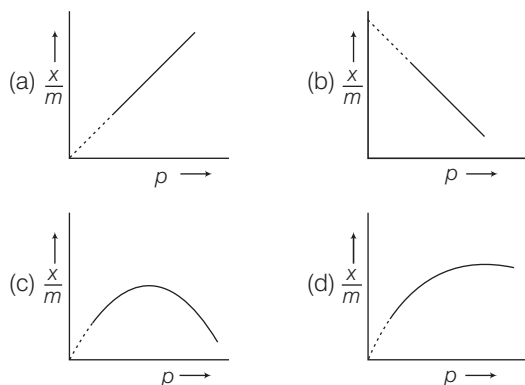

9 The Langmuir adsorption isotherm is deduced using which of the following assumptions?

- The adsorption takes place in multilayer
- The adsorbed molecules interact with each other
- The adsorption sites are equivalent in their ability to absorb the particles
- The heat of adsorption varies with coverage

10 Which of the following assumptions is not correct about Langmuir adsorption isotherm?

- The solid surface is homogeneous and has a fixed number of adsorption sites
- Every adsorption site is equivalent
- The adsorbed layer is not uniform all over the adsorbent
- The adsorbed gas behaves ideally in the vapour phase

11 In Langmuir's model of adsorption of a gas on a solid surface,

- the rate of dissociation of adsorbed molecules from the surface does not depend on the surface covered
- the adsorption at a single site on the surface may involve multiple molecules at the same time
- the mass of gas striking a given area of surface is proportional to the pressure of the gas
- the mass of gas striking a given area of surface is independent of the pressure of the gas

12 Surface area per gram of the adsorbent is called

- molar surface area
- normal surface area
- specific surface area
- equivalent surface area

13 The volume of the gases  $H_2$ ,  $CH_4$ ,  $CO_2$  and  $NH_3$  adsorbed by one of activated charcoal at 298 K are in order

- $H_2 > CO_2 > CH_4 > NH_3$
- $H_2 > CH_4 > CO_2 > NH_3$
- $NH_3 > CO_2 > CH_4 > H_2$
- $NH_3 > CH_4 > CO_2 > H_2$

14 The decomposition of  $H_2O_2$  may be checked by adding small quantity of phosphoric acid. This is an example of

- neutralisation
- negative catalysis
- positive catalysis
- catalytic poisoning

15  $KClO_3$  on heating decomposes into  $KCl$  and  $O_2$ . If some  $MnO_2$  is added, the reaction goes much faster because

- $MnO_2$  decomposes to give oxygen
- $MnO_2$  acts as catalyst
- $MnO_2$  provides heat by reacting
- $MnO_2$  provides better contact

16 Arrange the following diagrams in correct sequence of steps involved in the mechanism of catalysis in accordance with modern adsorption theory.

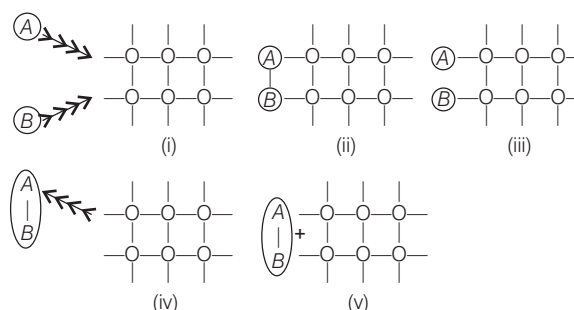

- (i)  $\rightarrow$  (ii)  $\rightarrow$  (iii)  $\rightarrow$  (iv)  $\rightarrow$  (v)
- (i)  $\rightarrow$  (iii)  $\rightarrow$  (ii)  $\rightarrow$  (iv)  $\rightarrow$  (v)
- (i)  $\rightarrow$  (iii)  $\rightarrow$  (ii)  $\rightarrow$  (v)  $\rightarrow$  (iv)
- (i)  $\rightarrow$  (ii)  $\rightarrow$  (iii)  $\rightarrow$  (v)  $\rightarrow$  (iv)

17 In which of the following reactions, heterogeneous catalysis is involved?

- $2SO_2(g) + O_2(g) \xrightarrow{NO(g)} 2SO_3(g)$
  - $2SO_2(g) \xrightarrow{Pt(s)} 2SO_3(g)$
  - $N_2(g) + 3H_2(g) \xrightarrow{Fe(s)} 2NH_3(g)$
  - $CH_3COOCH_3(l) + H_2O(l) \xrightarrow{HCl(l)} CH_3COOH(aq) + CH_3OH(aq)$
- (ii) and (iii)
  - (ii), (iii) and (iv)
  - (i), (ii) and (iii)
  - Only (iv)

18 Which one of the following is an example of homogeneous catalysis?

- Acid hydrolysis of methyl acetate
- Catalytic conversion of water gas to methanol
- Catalytic conversion of  $SO_2$  to  $SO_3$  in contact process
- Haber's process of synthesis of ammonia

19 It is instructed that automobiles with catalytic converter must use unleaded gasolines because

- leaded gasolines may give more fumes
- surface of the catalyst is rendered ineffective by adsorption of lead
- automobiles with catalytic converter cannot run on leaded gasolines
- unleaded gasoline is cheaper

20 The void space in zeolites forms more than 50% of the total volume which is occupied by

- silicates
- aluminates
- water molecules
- $Na^+$ ,  $Mg^{2+}$  and  $Ca^{2+}$  ions

- 21** Which of the following statements is incorrect?  
 (a) Catalysts only accelerate the rate of chemical equation  
 (b) Catalysts cannot start a chemical reaction  
 (c) Catalysts can retard the rate of a chemical reaction  
 (d) Catalysts can expedite and retard the rate of a chemical reaction

- 22** Which of the following small sized elements can replace the silicon and aluminium in the frame work at zeolites?

- (a) Boron (b) Magnesium  
 (c) Phosphorus (d) All of these

- 23** The catalyst which is a zeolite can convert alcohol to various types of gasoline (petrol) by shape selective catalysis is

- (a) erionite (b) ZSM-5  
 (c) gemelinite (d) fanzasite

- 24** The efficiency of an enzyme in catalysing a reaction is due to its capacity

- (a) to form an enzyme substrate complex  
 (b) to decrease the bond energies of the substrate molecule  
 (c) to change the shape of the substrate molecule  
 (d) None of the above

- 25.** Match the catalysts to the correct processes.

Catalyst	Process
(A) $\text{TiCl}_3$	(i) Wacker process
(B) $\text{PdCl}_2$	(ii) Ziegler- Natta polymerisation
(C) $\text{CuCl}_2$	(iii) Contact process
(D) $\text{V}_2\text{O}_5$	(iv) Deacon's process

- (a) (A)- (iii), (B) - (ii), (C) - (iv), (D) - (i) → JEE Main 2015  
 (b) (A)- (ii), (B) - (i), (C) - (iv), (D) - (iii)  
 (c) (A)- (ii), (B) - (iii), (C) - (iv), (D) - (i)  
 (d) (A)- (iii), (B) - (i), (C) - (ii), (D) - (iv)

- 26** Match the following and choose the correct option.

Column I	Column II
A. Activated charcoal	1. A device to adsorb poisonous gases
B. $x/m = kp^{1/n}$	2. One of the adsorbents
C. For humidity control	3. Silica gel
D. Gas masks	4. Freundlich adsorption isotherm

- |     |   |   |   |   |  |     |   |   |   |   |
|-----|---|---|---|---|--|-----|---|---|---|---|
|     | A | B | C | D |  | A   | B | C | D |   |
| (a) | 2 | 4 | 3 | 1 |  | (b) | 4 | 3 | 1 | 2 |
| (c) | 2 | 1 | 3 | 4 |  | (d) | 2 | 4 | 3 | 2 |

**Direction** (Q. Nos. 27-29) In the following question, an Assertion (A) followed by Reason (R) is given. Choose the correct option out of the following choices.

- (a) Both A and R are true and R is correct explanation of A  
 (b) Both A and R are true but R is not correct explanation of A  
 (c) A is true but R is false  
 (d) Both A and R are false

- 27 Assertion** (A) In chemisorption, adsorption keeps on increasing with temperature.

**Reason** (R) Heat keeps on providing more and more activation energy.

- 28 Assertion** (A) Fruit formation process shows increase in the rate with passage of time.

**Reason** (R) Hydrolysis of ester is homogeneous autocatalytic reaction.

- 29 Assertion** (A) Zeolites are water softener as well as catalyst.

**Reason** (R) The catalytic action of zeolites is based upon their shape selectivity.

## DAY PRACTICE SESSION 2

# PROGRESSIVE QUESTIONS EXERCISE

- 1** 50 mL of 1 M oxalic acid (molar mass = 126) is shaken with 0.5 g of wood charcoal. The final concentration of the solution after adsorption is 0.5 M. What is the amount of oxalic acid adsorbed per gram of carbon?

- (a) 3.15 (b) 1.575  
 (c) 6.30 (d) 12.60

- 2** Which of the following statements is false?

- (a) Adsorption may be monolayer or multilayer  
 (b) Increase of pressure increases the amount of adsorption  
 (c) Increase of temperature may decrease the amount of adsorption  
 (d) Particle size of adsorbent will not affect the amount of adsorption

- 3** 1g of charcoal adsorbs 100 mL of 0.5 M  $\text{CH}_3\text{COOH}$  to form a monolayer, and thereby the molarity of  $\text{CH}_3\text{COOH}$  reduces to 0.49 M. What is the surface area of charcoal used by each molecule of acetic acid?

[Surface area of charcoal =  $3.01 \times 10^{-2} \text{ m}^2/\text{g}$ ]

- (a)  $6.02 \times 10^{-20} \text{ m}^2$  (b)  $5.00 \times 10^{-19} \text{ m}^2$   
 (c)  $3.01 \times 10^{-2} \text{ m}^2$  (d)  $2.00 \times 10^{-19} \text{ m}^2$

- 4** On the basis of data given below, predict which of the following gases shows least adsorption on a definite amount of charcoal?

Gas	$\text{CO}_2$	$\text{SO}_2$	$\text{CH}_4$	$\text{H}_2$
Critical temp. (K)	304	630	190	33

- (a)  $\text{CO}_2$  (b)  $\text{SO}_2$  (c)  $\text{CH}_4$  (d)  $\text{H}_2$

- 5 Select the incorrect statement.
- The rate of enzyme catalysed reaction also depends upon enzyme concentration
  - The rate of enzyme catalysed reaction depends upon ionic strength
  - The rate of enzyme catalysed reaction first increases with temperature and then decreases after attaining optimum temperature
  - The increase in activity of protein as enzyme is due to denaturation
- 6 During the adsorption of krypton on activated charcoal at low temperature,
- $\Delta H > 0$  and  $\Delta S > 0$
  - $\Delta H < 0$  and  $\Delta S < 0$
  - $\Delta H > 0$  and  $\Delta S > 0$
  - $\Delta H < 0$  and  $\Delta S > 0$
- 7 In the Freundlich adsorption isotherm equation,  $\log \frac{x}{m} = \log k + \frac{1}{n} \log p$ , the value of  $n$  is
- any value from 0 to 1
  - a negative integer
  - a positive integer
  - a positive or negative integer

- 8 Which one of the following reactions is an example of auto-catalysis?

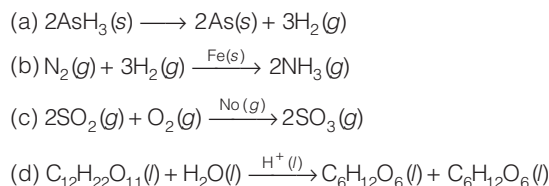

- 9 Given below, catalyst and corresponding process/ reaction are matched. The mismatch is

- $[\text{RhCl}(\text{PPh}_3)_2]$  : Hydrogenation
- $\text{TiCl}_4 + \text{Al}(\text{C}_2\text{H}_5)_3$  : Polymerisation
- $\text{V}_2\text{O}_5$  : Haber : Bosch process
- Nickel : Hydrogenation

- 10 According to Freundlich adsorption isotherm, which of the following is correct? → AIEEE 2012

- $\frac{x}{m} \propto p^0$
- $\frac{x}{m} \propto p^1$
- $\frac{x}{m} \propto p^{1/n}$
- All of these

## ANSWERS

SESSION 1	1 (c)	2 (b)	3 (d)	4 (a)	5 (b)	6 (a)	7 (b)	8 (d)	9 (c)	10 (c)
	11 (c)	12 (c)	13 (c)	14 (b)	15 (b)	16 (b)	17 (a)	18 (a)	19 (b)	20 (c)
	21 (a)	22 (d)	23 (b)	24 (a)	25 (b)	26 (a)	27 (d)	28 (a)	29 (a)	
SESSION 2	1 (c)	2 (d)	3 (b)	4 (d)	5 (d)	6 (b)	7 (c)	8 (a)	9 (c)	10 (d)

## Hints and Explanations

### SESSION 1

- Adsorption is a surface phenomenon because unutilised valencies are present only at the surface.
- For physical adsorption, as temperature increases, adsorption decreases.  
 $\text{Adsorbent} + \text{Adsorbate} \rightleftharpoons \text{Adsorbed state} + \Delta E$   
 Adsorption is an exothermic process (forward direction), desorption is endothermic process (backward direction). According to Le-Chatelier's principle, increase in temperature favours endothermic process.
- Adsorption is an exothermic process, i.e. energy is released against van der Waals' force of attraction (physisorption). Hence,  $\Delta H$  is always negative.
- Langmuir showed that at low pressure, the physically adsorbed gas forms only one molecule thick layer. However, above a certain pressure, multimolecular thick layer is formed.
- Adsorption of gases decreases with increase in temperature.
- In Freundlich adsorption isotherm,  $n > 1$ .

- 7 According to Freundlich adsorption isotherm,

$$\frac{x}{m} = kp^{1/n}$$

On taking logarithm of both sides, we get

$$\log \frac{x}{m} = \log k + \log p^{1/n} \quad \text{or} \quad \log \frac{x}{m} = \log k + \frac{1}{n} \log p$$

$$y = c + mx$$

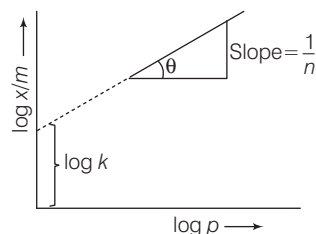

$$y = \log \frac{x}{m}, c = \text{intercept} = \log k,$$

$$m = \text{slope} = \frac{1}{n} \text{ and } x = \log p$$



- 8 At low pressure,  $\frac{x}{m} = kp$  and  
at high pressure,  $\frac{x}{m} = k$  (i.e. constant)  
Hence, option (d) is correct.
- 9 Langmuir adsorption isotherm is based on various assumptions. These are as follows:
- All sites are equivalent on a surface.
  - The layer is uniformly distributed all over i.e. unimolecular.
  - At equilibrium, rate of adsorption = rate of desorption.
- 10 Langmuir adsorption isotherm is based upon the fact that every adsorption site is equivalent and the binding ability of particles does not depend on nearby sites.
- 11 The adsorption of a gas is directly proportional to the pressure of the gas.
- 12 Specific surface area is the surface area per gram of the adsorbent.
- 13 The correct order of gases adsorbed by activated charcoal is  
 $\text{NH}_2 > \text{CO}_2 > \text{CH}_4 > \text{H}_2$   
Higher the critical temperature, more is the ease of liquefaction of a gas and greater is the amount of gas adsorbed.
- 14 If the addition of a substance decreases the rate of reaction, the process is called negative catalysis.
- 15  $\text{MnO}_2$  increases the rate of decomposition of  $\text{KClO}_3$  and act as catalyst.
- 16 (i)  $\rightarrow$  (iii)  $\rightarrow$  (ii)  $\rightarrow$  (iv)  $\rightarrow$  (v)
- 17 In heterogeneous catalysis, reactants and catalysts are in different phase. Only (ii) and (iii) reactions have different phase.
- 18 In acid hydrolysis of methyl acetate, the reactants as well as the catalyst are in same phase, i.e. aqueous. So, it is an example of homogeneous catalysis.
- 19 Surface of the catalyst is rendered ineffective by adsorption of lead.
- 20 More than 50% of the total volume of the void space in zeolite is occupied by water molecules.
- 21 Catalysts can accelerate as well as retard the rate of a chemical reaction. However, they never initiate a chemical reaction.
- 22 B, Mg and P can replace the Si and Al in the frame work at zeolites.

- 23 ZSM-5 is a shape selective catalyst that catalyse the conversion of alcohols to various gasoline.
- 24 Enzyme + substrate  $\longrightarrow$  [Complex intermediate]  $\longrightarrow$  Product + Enzyme
- 25 (a)  $\text{TiCl}_3$  is used as Ziegler-Natta catalyst for the polymerisation of ethene.  
(b)  $\text{PdCl}_2$  is used in Wacker process, in which alkene changed into aldehyde via catalytic cyclic process initiated by  $\text{PdCl}_2$ .  
(c)  $\text{CuCl}_2$  is used in Deacon's process. (for  $\text{Cl}_2$ )  
(d)  $\text{V}_2\text{O}_5$  is used in contact process for manufacturing sulphuric acid.
- 26 Gas mask works on the principle of adsorption.
- Activated charcoal act as adsorbent.
  - $x/m = kp^{1/n}$  is the equation for freundlich adsorption isotherm.
  - Silica gel is used to control humidity.
- Hence, A  $\rightarrow$  2, B  $\rightarrow$  4, C  $\rightarrow$  3, D  $\rightarrow$  1
- 27 In chemisorption, adsorption first increases and then decreases with change in temperature.
- 28 Fruit formation process shows increase in the rate with passage of time. It is the homogeneous catalytic reaction.
- 29 Zeolites are water softener as well as shape selective catalyst.

## SESSION 2

- 1 50 mL of 1 M oxalic acid  
= 50 millimol = 0.050 mol  
=  $0.050 \times 126 \text{ g} = 6.3 \text{ g}$   
50 mL of 0.5 M oxalic acid = 3.15 g  
Adsorbed oxalic acid  
=  $6.30 - 3.15$   
= 3.15 g on 0.5 g charcoal  
Amount of oxalic acid adsorbed per gram of charcoal =  $\frac{3.15}{0.5} = 6.3$
- 2 Physisorption is multilayer while chemisorption is monolayer. Extent of adsorption is affected by pressure, temperature and particle size of adsorbent.
- 3 100 mL of 0.5 M  $\text{CH}_3\text{COOH}$  contains  
= 0.05 mol  
After adsorption,  $\text{CH}_3\text{COOH}$  remained  
= 0.049 mol  
 $\therefore$  Acetic acid adsorbed = 0.001 mol  
=  $6.02 \times 10^{20}$  molecules

$\therefore$  Surface area of charcoal adsorbed by each molecule

$$= \frac{3.01 \times 10^2 \text{ m}^2}{6.02 \times 10^{20}} = 5 \times 10^{-19} \text{ m}^2$$

- 4 Higher the critical temperature, greater is the adsorption.  $\text{H}_2$  has lowest critical temperature and hence, is least adsorbed.
- 5 Denaturation means biologically inactive protein. Thus activity of enzyme decreases.
- 6 Adsorption is an exothermic process, thus  $\Delta H$  is negative (i.e.  $\Delta H < 0$ ). Moreover, adsorption results in more ordered arrangements of molecules, thus entropy decreases (i.e.  $\Delta S < 0$ ).

$$\Delta G = \Delta H - T\Delta S$$

Hence, low temperature favours the reaction.

- 7  $n$  is a positive integer, and it is a constant that depend upon the nature of adsorbate and adsorbent at a particular temperature. The factor  $\frac{1}{n}$  has values between 0 and 1.
- 8 The reactions which are catalysed by one of the product formed are called autocatalysis reactions and the process is called autocataysis e.g.

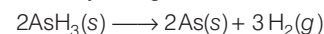

- 9 In Haber-Bosch process, i.e. for the manufacture of  $\text{NH}_3$ , finely divided iron + molybdenum as promotor is used as catalyst.

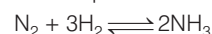

- 10 By Freundlich adsorption isotherm,

$$\frac{x}{m} = kp^{1/n}$$

(in between low and high pressure)

$$\text{When } n = 1, \frac{x}{m} \propto p^1$$

(in lower pressure range)

$$\text{when } n \text{ is large, } \frac{x}{m} = k$$

(independent of pressure)

$$\text{Thus, } \frac{x}{m} \propto p^0$$

(in high pressure range when saturation point is reached)

